

Odszyfruj nazwy obrazków i połącz je z poprawnym zapisem.

KASZMIN	PUSZKA
KASZKLAN	PIETRUSZKA
ŁASZKO	MATRIOSZKA
KASZPIL	SZMINKA
TANKASZ	SZKOŁA
KAPUSZ	SZPITAL
KISZNINAU	BROSZKA
KATRUSZPIE	SZKLANKA
KAGRUSZ	KASZTAN
TALSZPI	GRUSZKA
SZKABRO	SZPILKA
SZKATRIOMA	NAUSZNIKI

Otocz niebieską pętelką obrazki, których nazwy rozpoczynają się na sylabę ŻA, a czerwoną obrazki, których nazwy rozpoczynają się na sylabę ŻY. Powtórz nazwy obrazków. Pokoloruj.

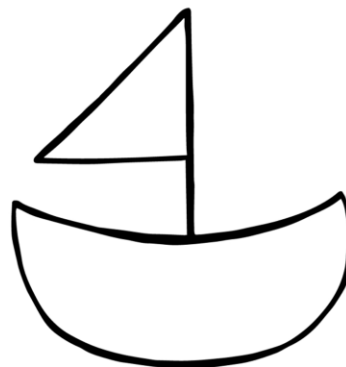
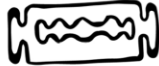
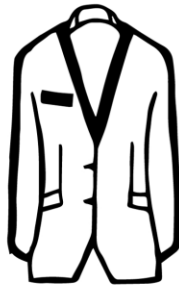
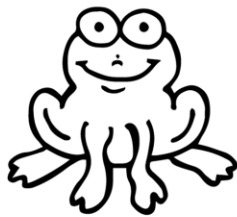

Połącz mały obrazek z takim samym dużym.  
Powtórz nazwy obrazków. Pokoloruj.

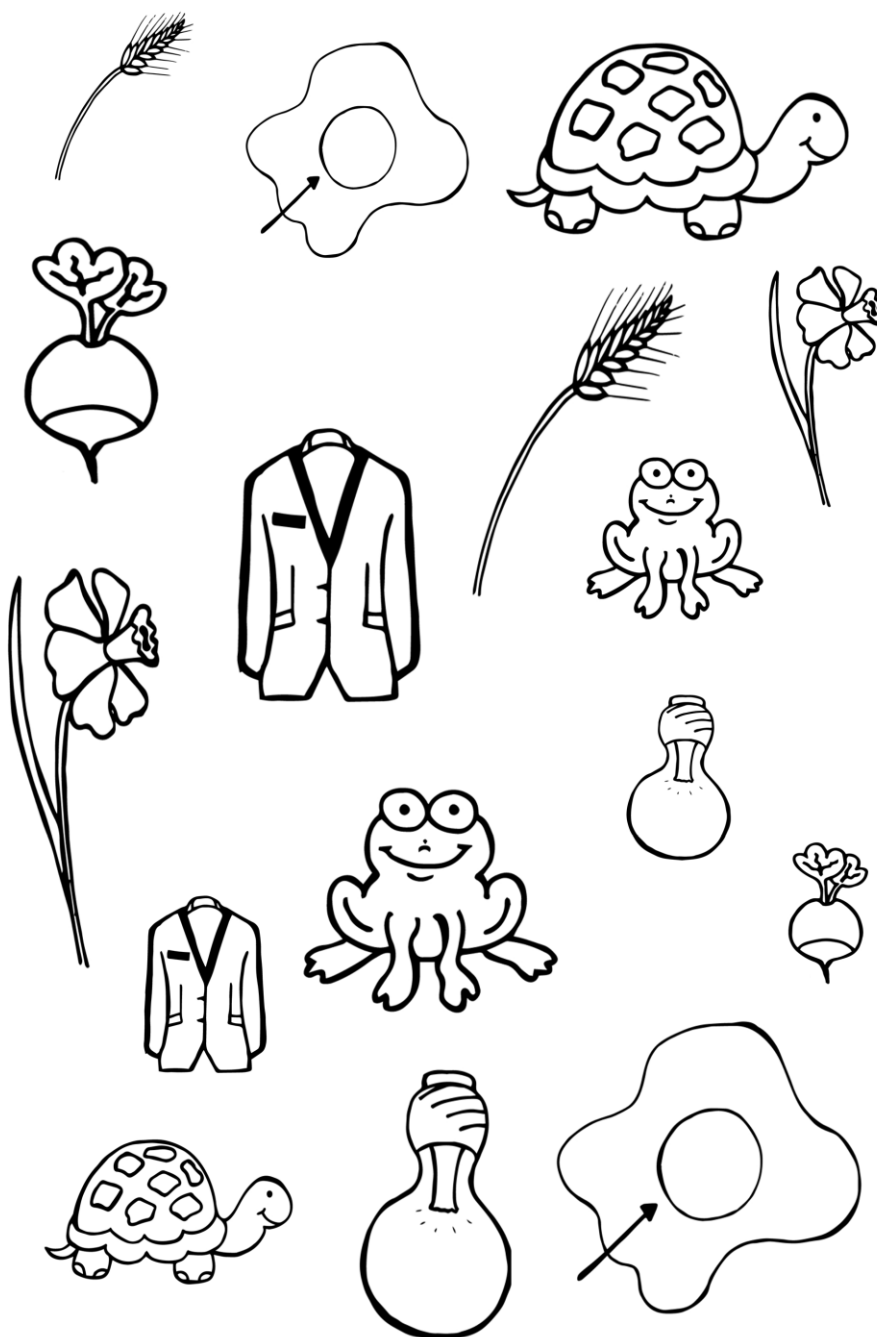

Połącz obrazek z odpowiednią nazwą.  
Powtórz nazwy obrazków. Pokoloruj.

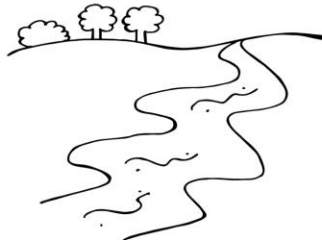
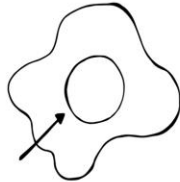
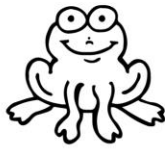

ŻYTO

ŻÓŁW

ŻABA

RZODKIEWKA

ŻYRAFA

RZEKA

ŻAKIET

ŻÓŁTKO

ŻAGLÓWKA

ŻONKIL

ŻYLETKA

ŻARÓWKA

Skreśl w każdym rzędzie obrazek, w którego nazwie nie usłyszysz głoski Ż.

Powtórz nazwy obrazków. Pokoloruj.

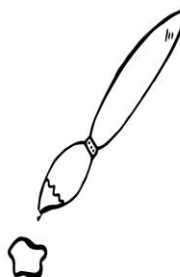
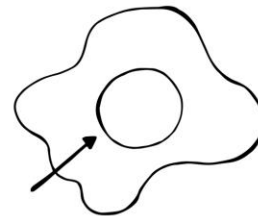
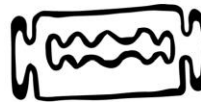
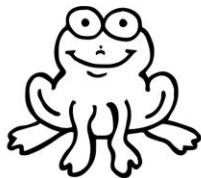
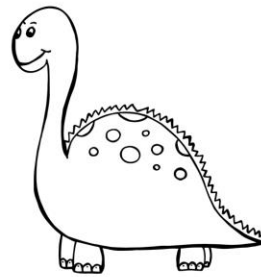
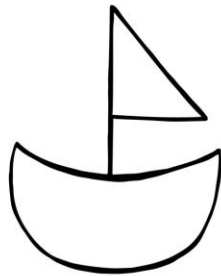
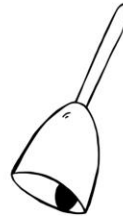
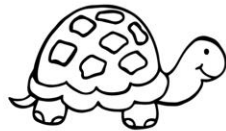

Odszyfruj nazwy obrazków i połącz je z poprawnym zapisem.

KILŻON

ŻYRAFA

WŁÓŻ

RZODKIEWKA

RAWŻU

ŻÓŁW

BAŻA

ŻABA

TKOŻÓŁ

ŻONKIL

FARAŻY

ŻARÓWKA

KUŻ

ŻURAW

KAKIEWRZOD

ŻÓŁTKO

GIELŻA

ŻAGŁÓWKA

KAGŁÓWŻA

RZEKA

RBUŻ

ŻUK

KARZE

ŻAGIEL

KARÓWŻA

ŻUBR

Połącz pasujące do siebie obrazki.  
Zwróć uwagę na sylaby i powtórz je.  
Pokoloruj.

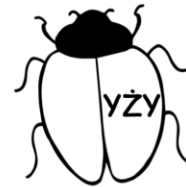

Połącz pasujące do siebie obrazki.  
Zwróć uwagę na sylaby i powtórz je.  
Pokoloruj.

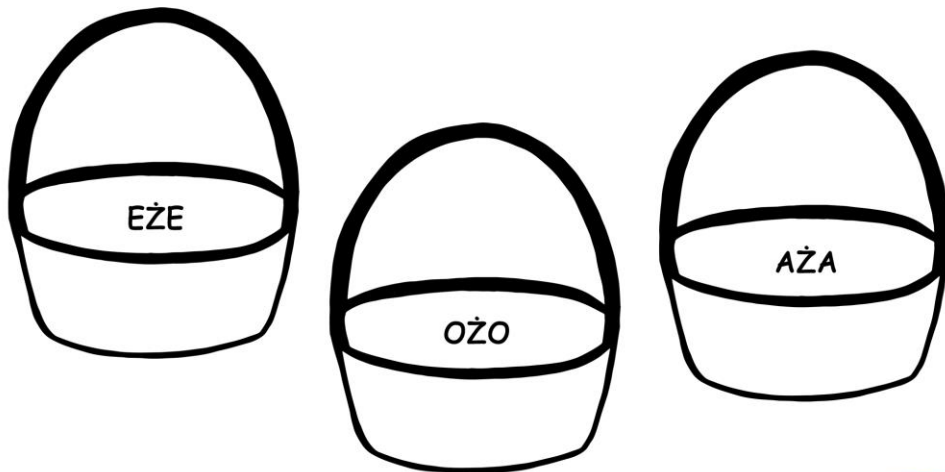
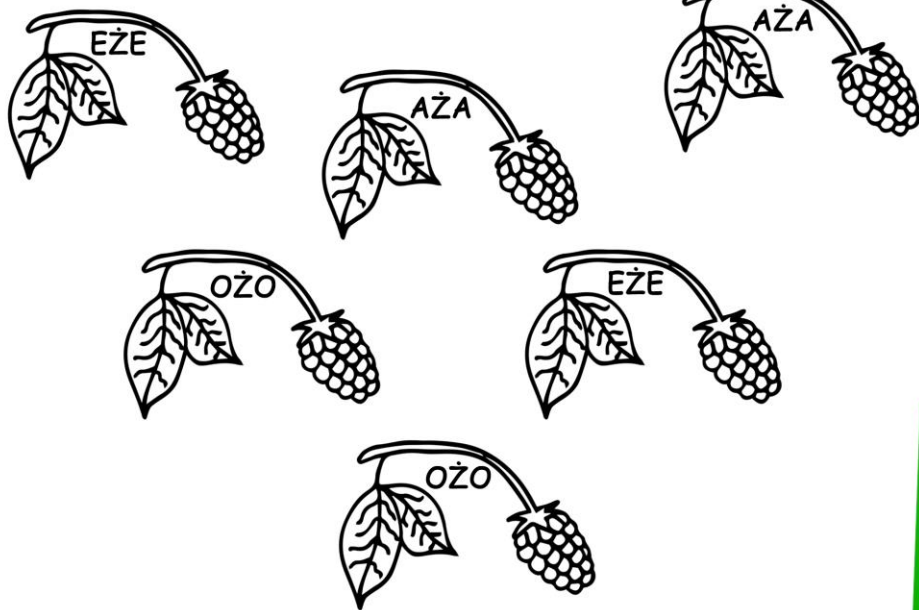



Połącz pasujące do siebie obrazki.  
Zwróć uwagę na sylaby i powtórz je.  
Pokoloruj.



Pomóż małemu jeżowi dotrzeć do jego mamy.  
Powtórz sylaby napotkane po drodze.  
Pokoloruj.

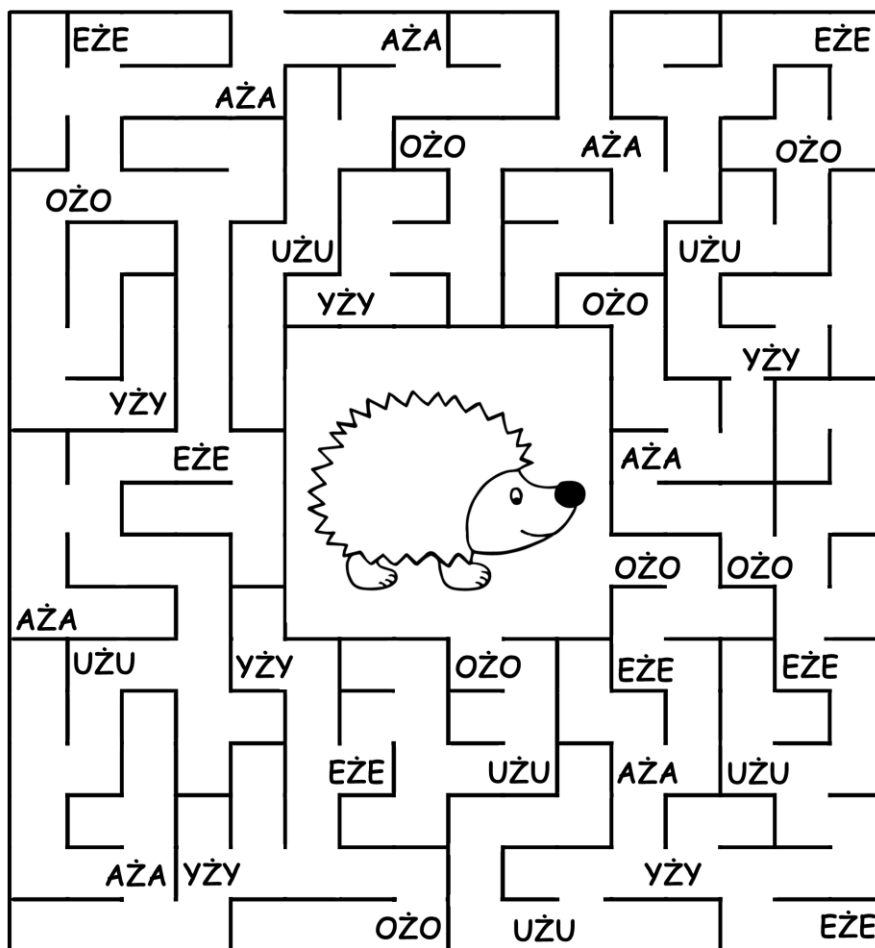
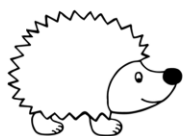

Otocz niebieską pętelką obrazki, których nazwy rozpoczynają się na głoskę J, a czerwoną obrazki, których nazwy rozpoczynają się na inne głoski. Powtórz nazwy obrazków. Pokoloruj.

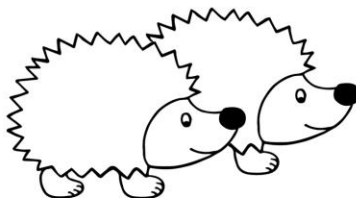
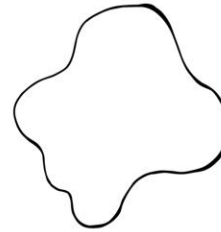
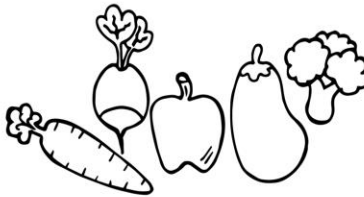

Połącz mały obrazek z takim samym dużym.  
Powtórz nazwy obrazków. Pokoloruj.



Połącz obrazek z odpowiednią nazwą.  
Powtórz nazwy obrazków. Pokoloruj.

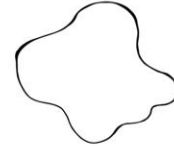
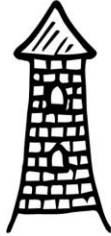

RÓŻA



NÓŻ

FILIŻANKA

LEŻAK



JARZĘBINA

KAŁUŻA

JEŻE

WARZYWA



ORZECH

JEŻYNY

WIEŻA



BURZA

KORZENIE

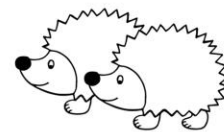
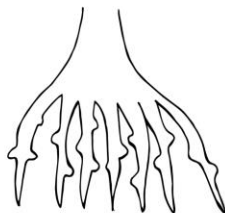

Skreśl w każdym rzędzie obrazek, w którego nazwie nie usłyszysz głoski Ż.  
Powtórz nazwy obrazków. Pokoloruj.

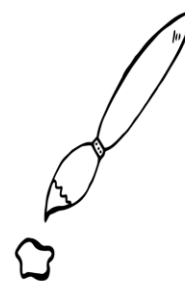
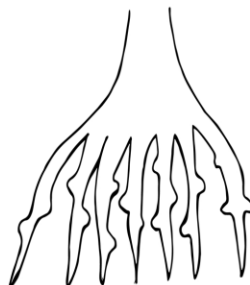
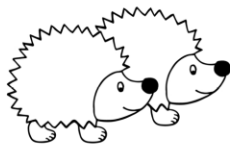
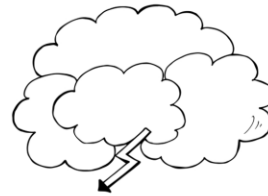
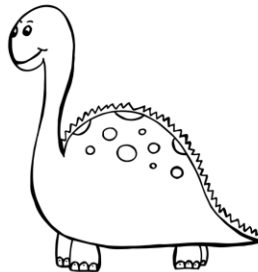

Odszyfruj nazwy obrazków i połącz je z poprawnym zapisem.

NABIRZĘJA

FILIŻANKA

RZECHO

RÓŻA

EŻJE

NÓŻ

ŻARÓ

LEŻAK

NIERZEKO

JARZĘBINA

ŻAKLE

KAŁUŻA

ŻÓN

JEŻE

KAŻANLIFI

ORZECH

ŻAŁUKA

WIEŻA

RZABU

BURZA

ŻAWIE

KORZENIE

Otocz niebieską pętelką obrazki, których nazwy rozpoczynają się na głoskę G, a czerwoną obrazki, których nazwy rozpoczynają się na inne głoski. Powtórz nazwy obrazków. Pokoloruj.

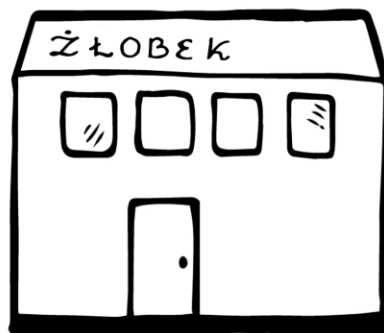
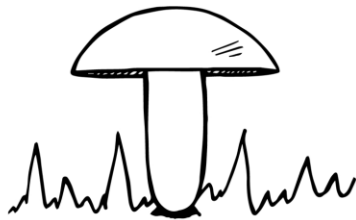
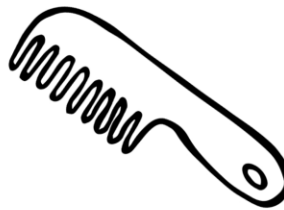
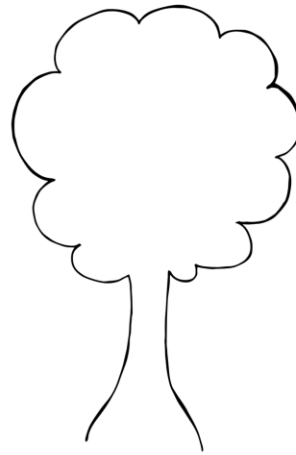
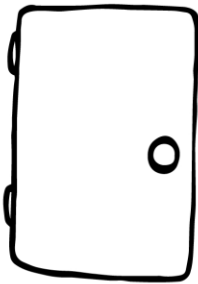



Połącz mały obrazek z takim samym dużym.  
Powtórz nazwy obrazków. Pokoloruj.



Połącz obrazek z odpowiednią nazwą.  
Powtórz nazwy obrazków. Pokoloruj.



ŁYŻWY



GRZECHOTKA



ŻŁOBEK



ŻMIJA

DRZWI



GRZYB

DRZEWO



GRZEBIEŃ

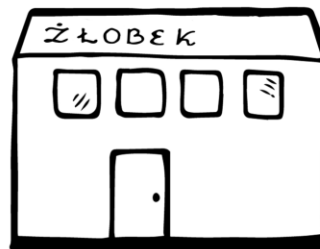
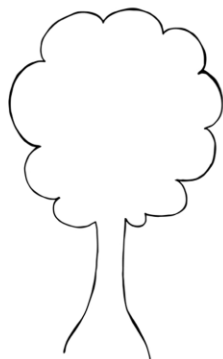

Skreśl w każdym rzędzie obrazek, w którego nazwie nie usłyszysz głoski Ż.  
Powtórz nazwy obrazków. Pokoloruj.

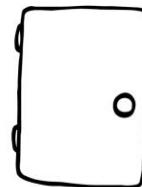
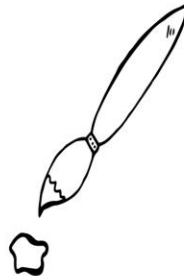
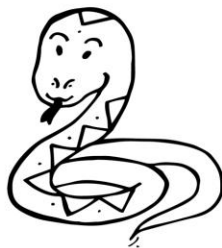
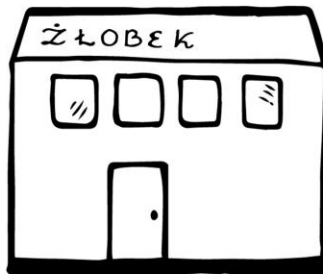
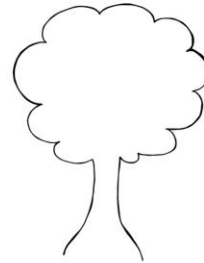
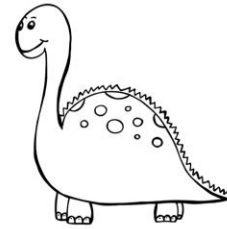
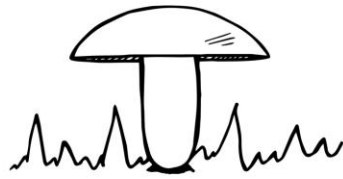

Odszyfruj nazwy obrazków i połącz je z poprawnym zapisem.

IWRZD

ŻMIJA

BYRZG

ŻŁOBEK

BEKŻŁO

ŁYŻWY

JAŻMI

GRZECHOTKA

BIEŃGRZE

DRZWI

KACHOTGRZE

GRZYB

WYŁYŻ

DRZEWO

WODRZE

GRZEBIEŃ