

Pomóż Maksowi dotrzeć do lasu.
Powtórz wszystkie sylaby napotkane po drodze.

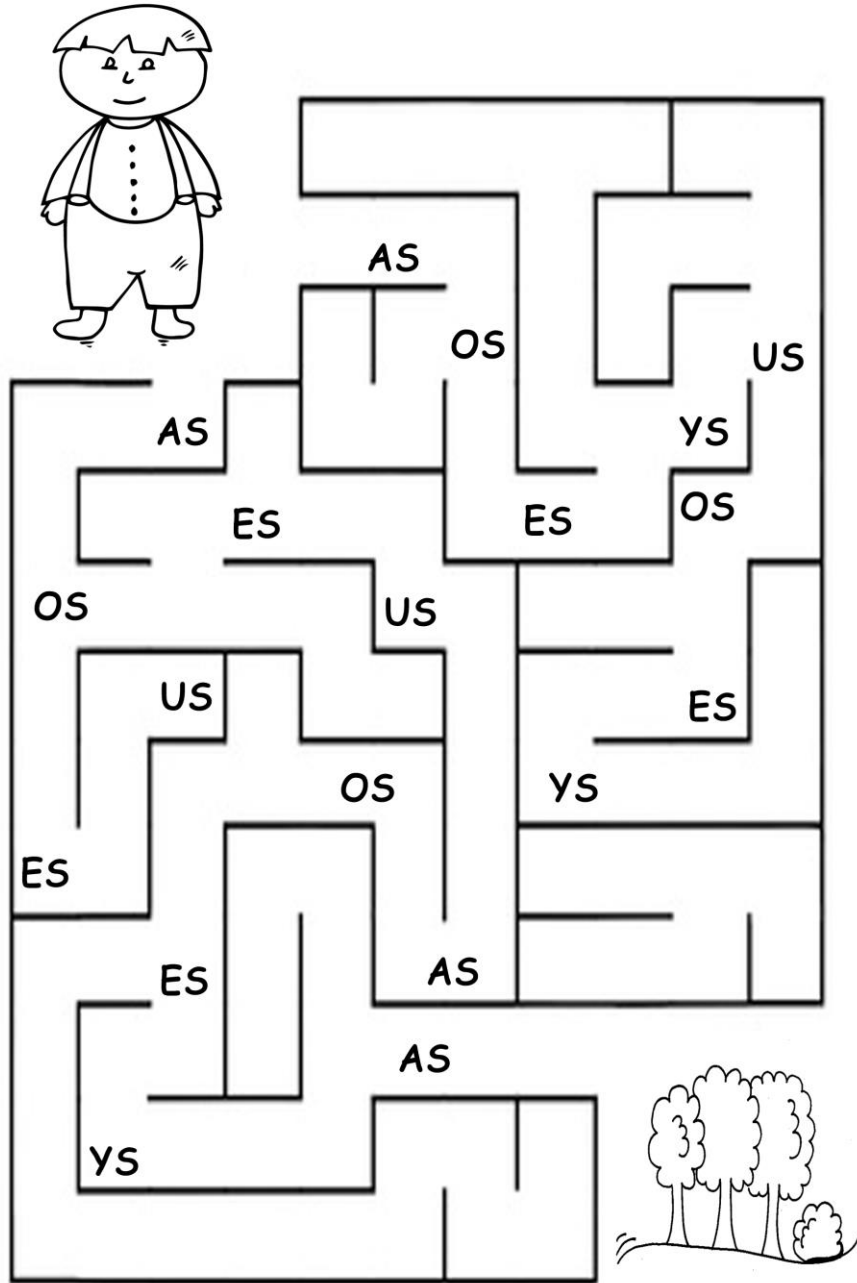

Połącz ze sobą połówki tych samych obrazków.
Powtórz głośno nazwy obrazków.
Pokoloruj.

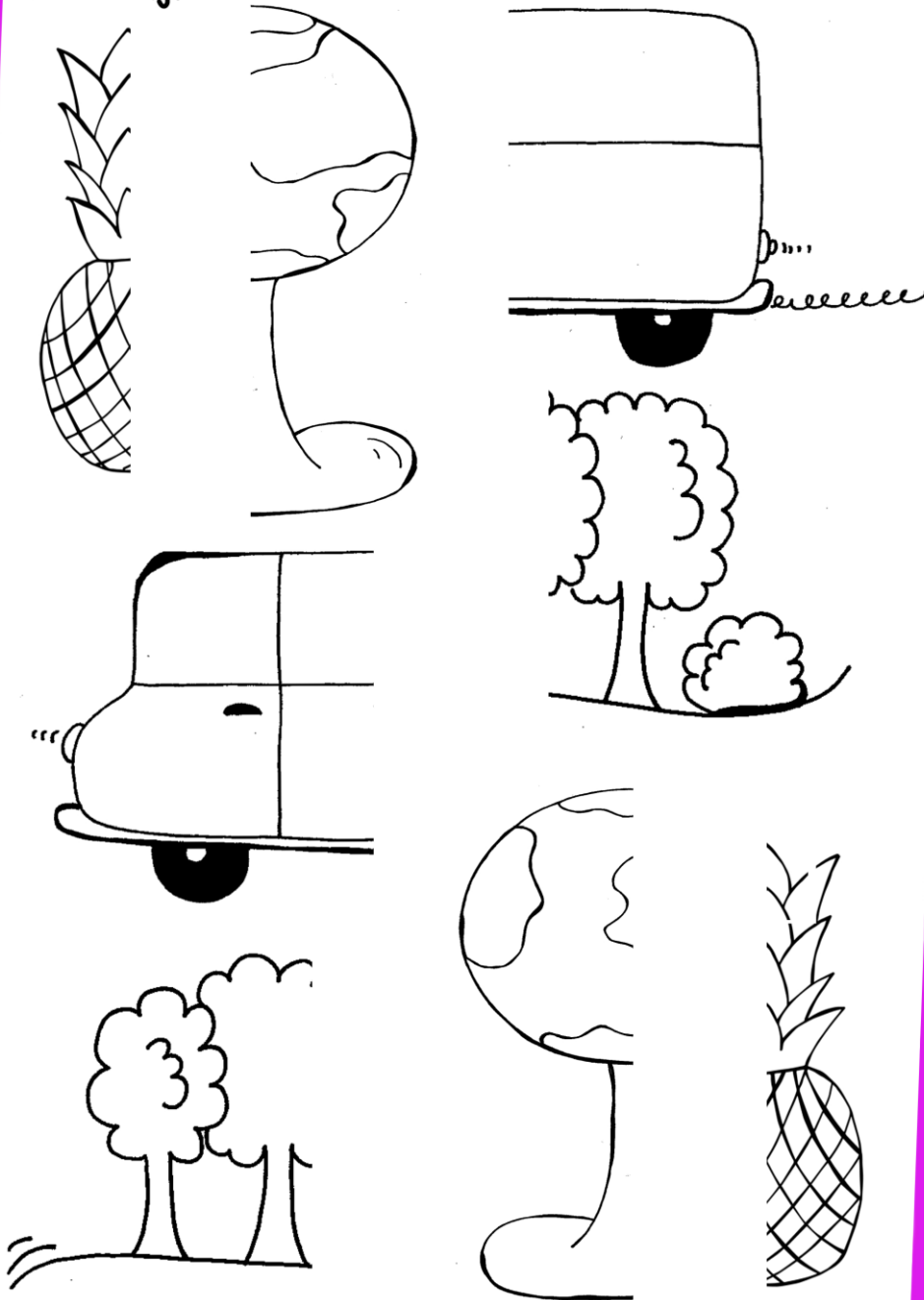

Połącz mały obrazek z takim samym dużym.
Powtórz nazwy obrazków.
Pokoloruj.

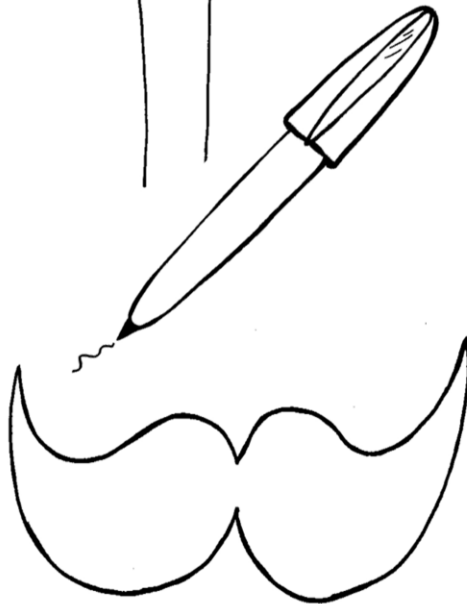
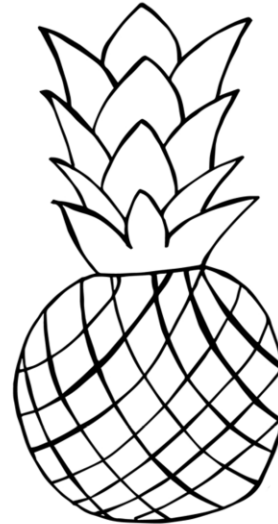
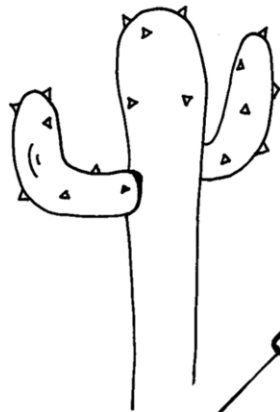
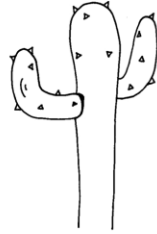
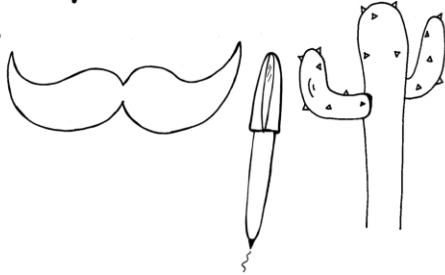

Otocz pętelką obrazki, których nazwy kończą się na głoskę S.

Powtórz te wyrazy. Pokoloruj.

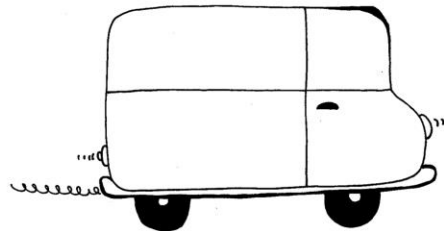
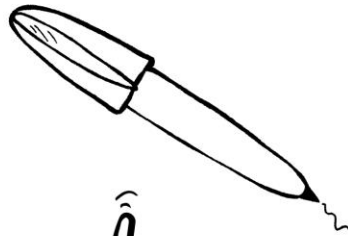
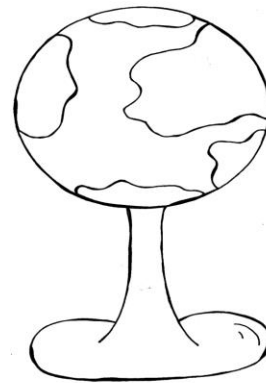
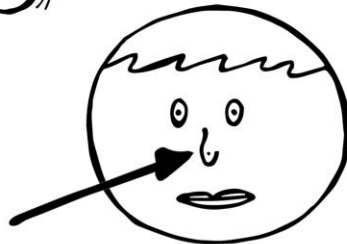
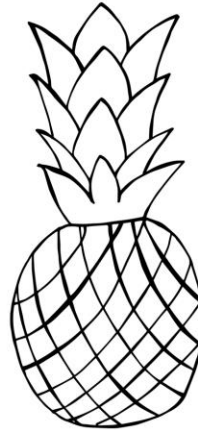

Połącz obrazek z podpisem.
Powtórz nazwy obrazków. Pokoloruj.

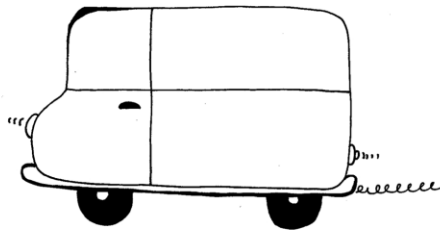
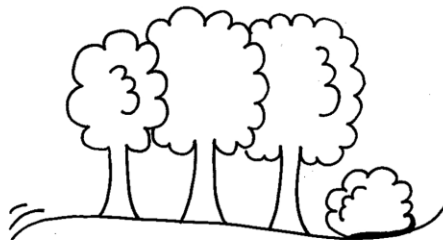
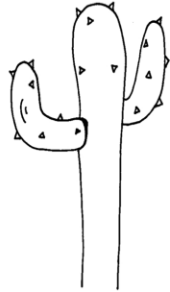

PIES

KAKTUS

AUTOBUS

WĄS

ANANAS

DŁUGOPIS

LAS