

Połącz obrazek z odpowiednią nazwą.  
Powtórz nazwy obrazków. Pokoloruj.

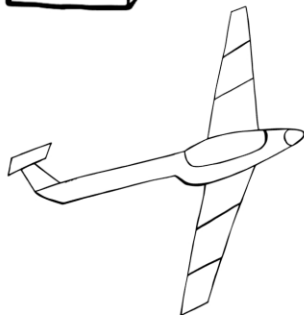
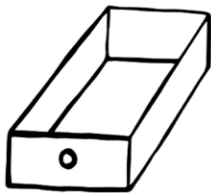
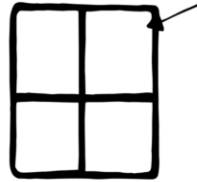

SZABLA

SZAFKA

SZYJA

SZACHY

SZYBA

SZELKI

SZYNKA

SZALIK

SZOPKA

SZYBOWIEC

SZORTY

SZUFLADA

SZAMPON

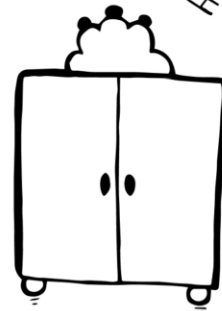
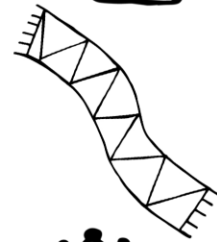

Skreśl w każdym rzędzie obrazek, w którego nazwie nie usłyszysz głoski SZ.

Powtórz nazwy obrazków. Pokoloruj.



Odszyfruj nazwy obrazków i połącz je z poprawnym zapisem.

BLASZA	SZYBOWIEC
PONSZAM	SZAMPON
KASZOP	SZUFELKA
WIECBOSZY	SZUFLADA
KAFELSZU	SZABLA
BASZY	SZOPKA
DAFLASZU	SZYBA
CHYSZA	SZYJA
KASZYN	SZYNY
JASZY	SZACHY
NYSZY	SZYNKA
KISZEL	SZELKI

Połącz pasujące do siebie obrazki.  
Zwróć uwagę na sylaby i powtórz je.  
Pokoloruj.

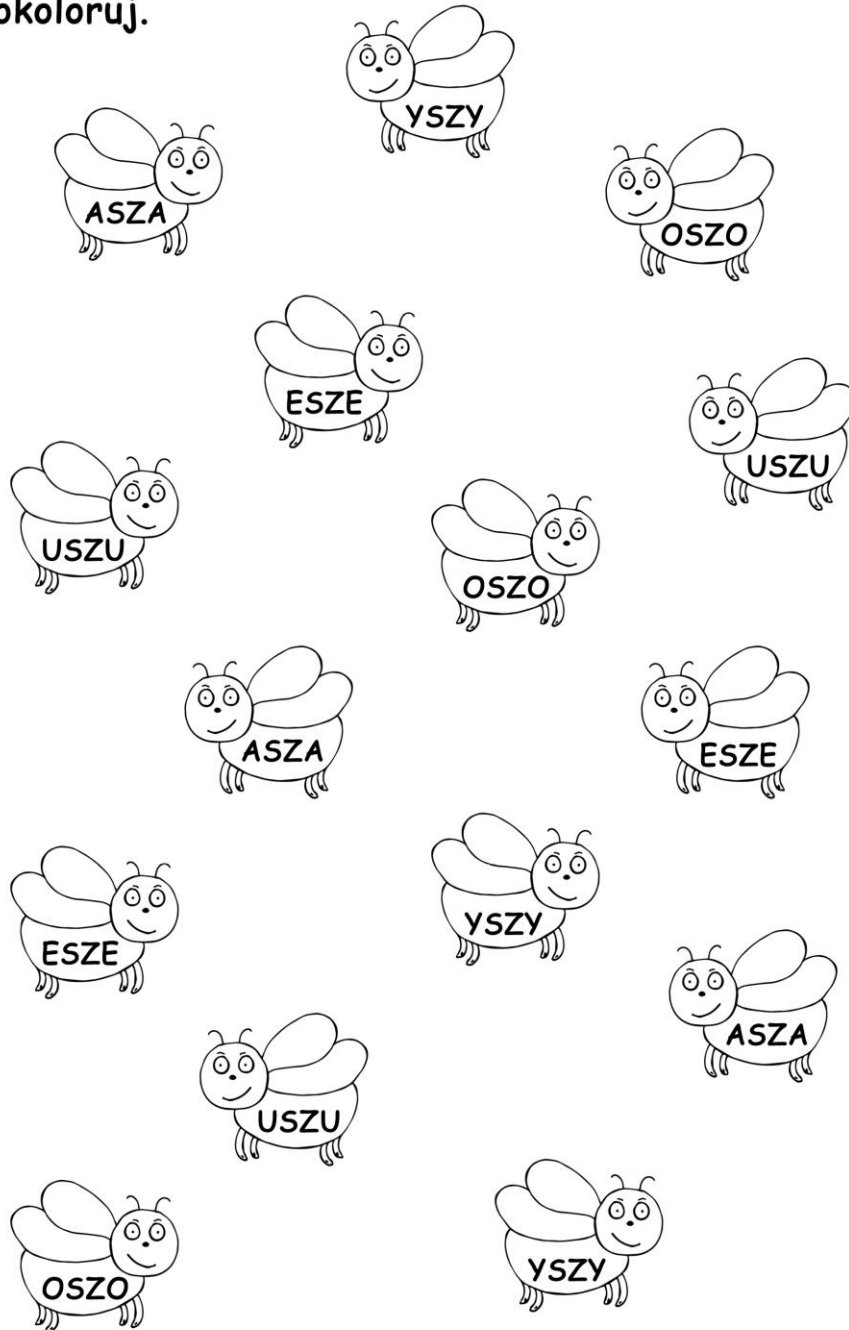

Połącz pasujące do siebie obrazki.  
Zwróć uwagę na sylaby i powtórz je.  
Pokoloruj.



Połącz pasujące do siebie obrazki.  
Zwróć uwagę na sylaby i powtórz je.  
Pokoloruj.

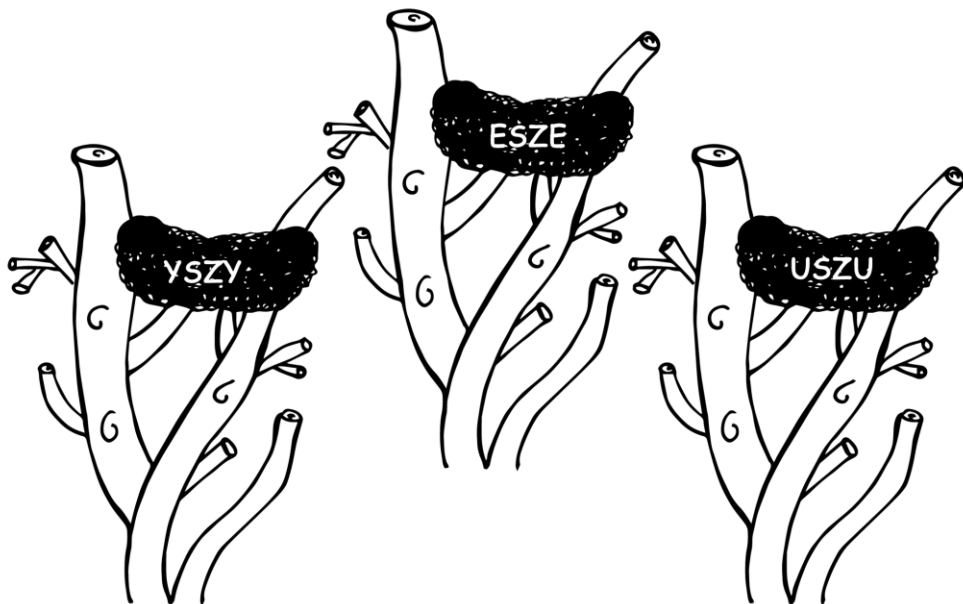
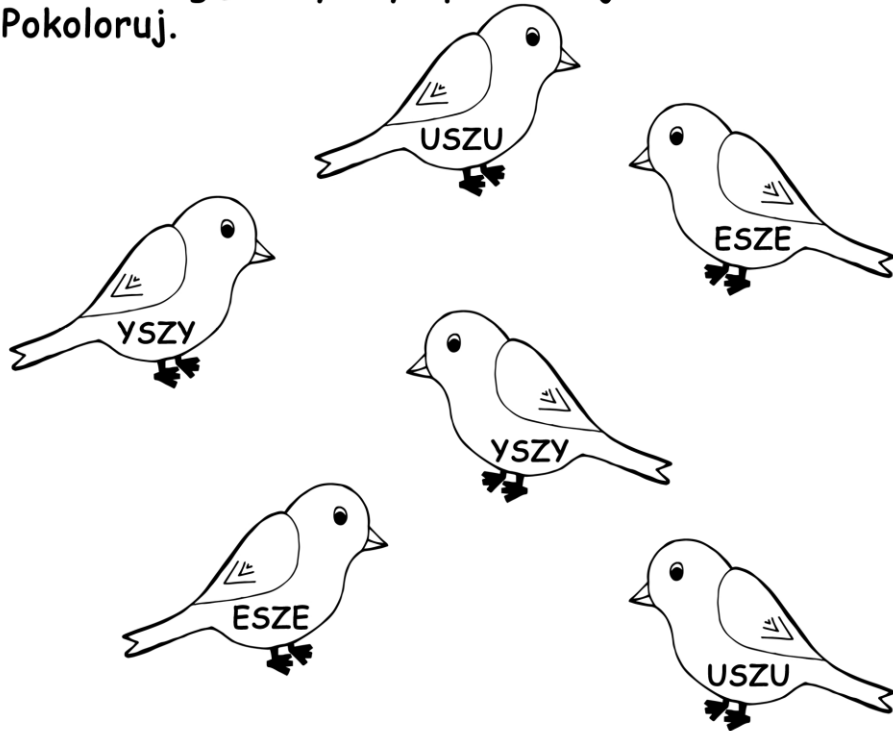

Pomóż Agnieszce odnaleźć jej naszyjnik.  
Powtórz sylaby napotkane po drodze.  
Pokoloruj.

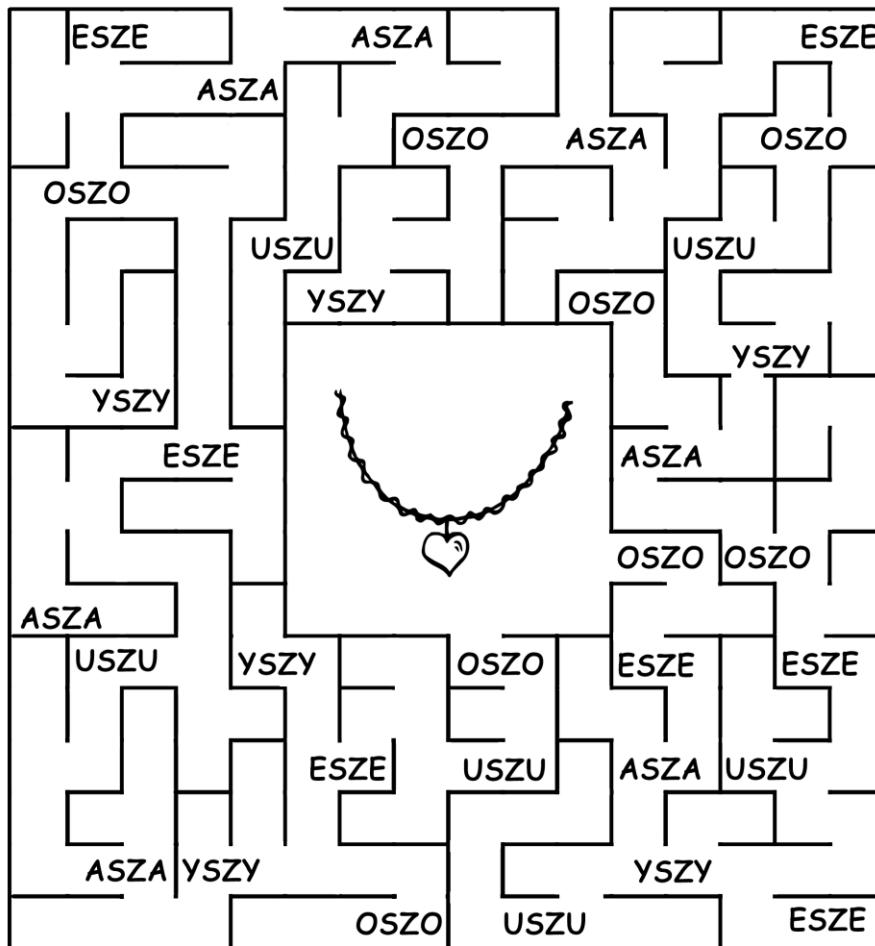

Otocz niebieską pętelką obrazki, których nazwy rozpoczynają się na głoskę K, a czerwoną obrazki, których nazwy rozpoczynają się na inne głoski. Powtórz nazwy obrazków. Pokoloruj.

